



IR Emitter and Detector Product Data Sheet LTE-1252

Spec No. :DS50-2017-0015
Effective Date: 03/16/2017
Revision: -

LITE-ON DCC

RELEASE

BNS-OD-FC001/A4

IR Emitter and Detector LTE-1252

1. Description

Lite-On offers a broad range of discrete infrared components for application such as remote controller, IR wireless data transmission, security alarm & etc. The product line includes GaAs 940nm IREDs, AlGaAs high power 880nm IREDs, AlGaAs high speed 875nm/850nm IREDs, PIN Photodiodes, Phototransistor and Photodarlington.

1.1. Features

- Lead (Pb) free product and RoHS compliant.
- Special for high current and low forward voltage
- Low cost miniature plastic end looking package
- Wide viewing angle
- High radiant intensity
- Clear transparent package

1.2. Applications

- 940nm IR emitter
- Sensor
- Night vision

2. Outline Dimensions

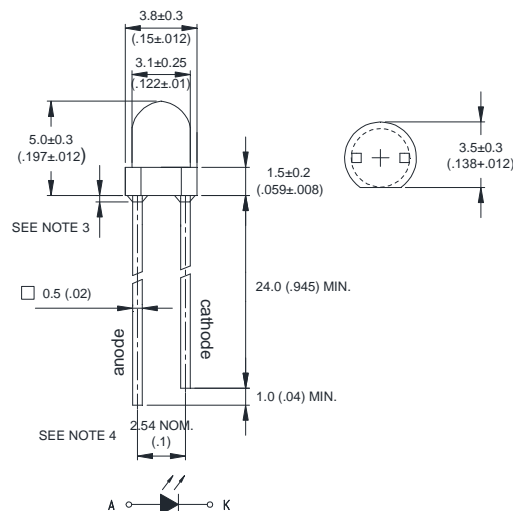

Notes :

1. All dimensions are in millimeters (inches).
2. Tolerance is $\pm 0.25\text{mm}$ (.010") unless otherwise noted.
3. Protruded resin under flange is 0.5mm (.02") max.
4. Lead spacing is measured where the leads emerge from the package.
5. Specifications are subject to change without notice.
6. Manufacturing site: Thailand & ChangZhou

IR Emitter and Detector LTE-1252

3. Absolute Maximum Ratings at TA=25°C

Parameter	Maximum Rating	Unit
Power Dissipation	150	mW
Peak Forward Current (300pps, 10µs pulse)	1	A
Continuous Forward Current	100	mA
Reverse Voltage	5	V
Operating Temperature Range	-40°C to + 85°C	
Storage Temperature Range	-55°C to + 100°C	
Lead Soldering Temperature [2.0mm (.063") From Body]	260°C for 5 Seconds	

4. Electrical / Optical Characteristics at TA=25°C

Parameter	Symbol	Min.	Typ.	Max.	Unit	Test Condition
Radiant Intensity	I_E	40	70		mW/sr	$I_F = 100\text{mA}$ $\theta = 0\text{deg}$
Peak Emission Wavelength	λ_{Peak}		940		nm	$I_F = 100\text{mA}$
Spectral Line Half-Width	$\Delta\lambda$		54		nm	$I_F = 100\text{mA}$
Forward Voltage	V_F	1.30	1.53	1.83	V	$I_F = 100\text{mA}$
*Reverse Current	I_R			100	µA	* $V_R = 5\text{V}$
Value Angle	$\theta_{0.5}$		40		deg	(see Fig.6)

*Note: Reverse voltage (VR) condition is applied for test only. This device is not designed for reverse operation.

IR Emitter and Detector LTE-1252

5. Typical Electrical / Optical Characteristics Curves

(25°C Ambient Temperature Unless Otherwise Noted)

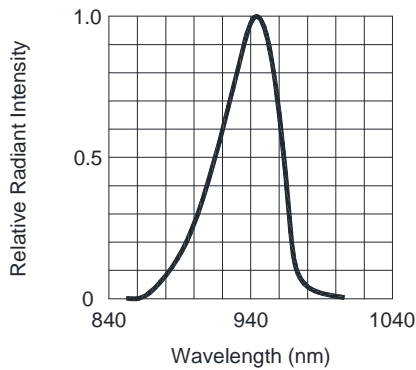

FIG.1 SPECTRAL DISTRIBUTION

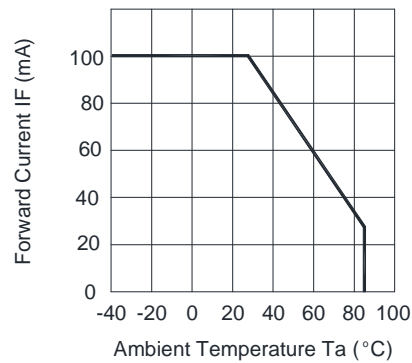

FIG.2 FORWARD CURRENT VS. AMBIENT TEMPERATURE

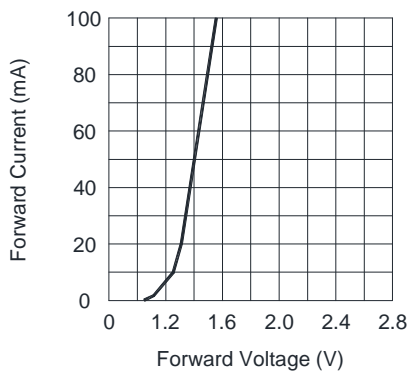

FIG.3 FORWARD CURRENT VS. FORWARD VOLTAGE

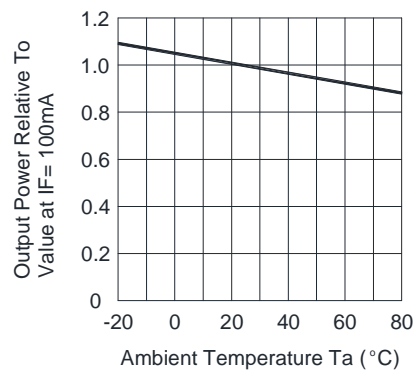

FIG.4 RELATIVE RADIANT INTENSITY VS. AMBIENT TEMPERATURE

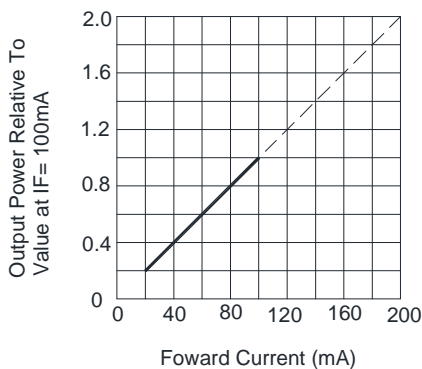

FIG.5 RELATIVE RADIANT INTENSITY VS. FORWARD CURRENT

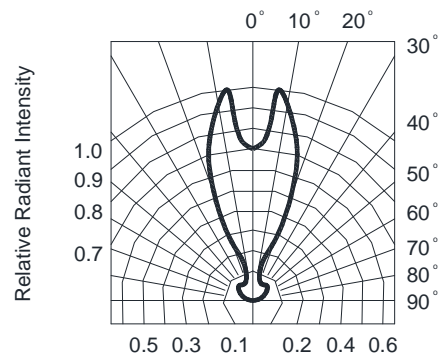

FIG.6 RADIATION DIAGRAM

IR Emitter and Detector LTE-1252

6. CAUTIONS

6.1. Application

The LEDs described here are intended to be used for ordinary electronic equipment (such as office equipment, communication equipment and household applications). Consult Liteon's Sales in advance for information on applications in which exceptional reliability is required, particularly when the failure or malfunction of the LEDs may directly jeopardize life or health (such as in aviation, transportation, traffic control equipment, medical and life support systems and safety devices).

6.2. Storage

The storage ambient for the LEDs should not exceed 30°C temperature or 70% relative humidity. It is recommended that LEDs out of their original packaging are used within three months. For extended storage out of their original packaging, it is recommended that the LEDs be stored in a sealed container with appropriate desiccant or in desiccators with nitrogen ambient.

6.3. Cleaning

Use alcohol-based cleaning solvents such as isopropyl alcohol to clean the LEDs if necessary.

6.4. Lead Forming & Assembly

During lead forming, the leads should be bent at a point at least 3mm from the base of LED lens. Do not use the base of the lead frame as a fulcrum during forming. Lead forming must be done before soldering, at normal temperature. During assembly on PCB, use minimum clinch force possible to avoid excessive mechanical stress.

6.5. Soldering

When soldering, leave a minimum of 3mm clearance from the base of the lens to the soldering point. Dipping the lens into the solder must be avoided. Do not apply any external stress to the lead frame during soldering while the LED is at high temperature. **Recommended soldering conditions:**

Soldering iron		Wave soldering	
Temperature	350°C Max.	Pre-heat	100°C Max.
Soldering time	3 seconds Max. (one time only)	Pre-heat time	60 seconds Max.
Position	No closer than 2mm from the base of the epoxy bulb	Solder wave	260°C Max.
		Soldering time	5 seconds Max.
		Dipping Position	No lower than 2mm from the base of the epoxy bulb

Note: Excessive soldering temperature and/or time might result in deformation of the LED lens or catastrophic failure of the LED. IR reflow is not suitable process for through hole type LED lamp product.

6.6. Drive Method

An LED is a current-operated device. In order to ensure intensity uniformity on multiple LEDs connected in parallel in an application, it is recommended that a current limiting resistor be incorporated in the drive circuit, in series with each LED as shown in Circuit A below.

Circuit model (A)

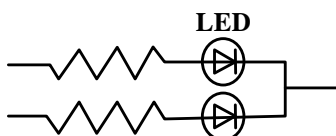

(A) Recommended circuit

Circuit model (B)

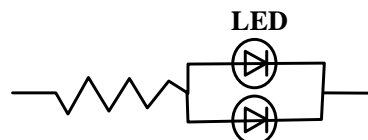

(B) The brightness of each LED might appear different due to the differences in the I-V characteristics of those LEDs.

IR Emitter and Detector LTE-1252

6.7. ESD (Electrostatic Discharge)

Static Electricity or power surge will damage the LED.

Suggestions to prevent ESD damage:

- Use a conductive wrist band or anti- electrostatic glove when handling these LEDs
- All devices, equipment, and machinery must be properly grounded
- Work tables, storage racks, etc. should be properly grounded
- Use ion blower to neutralize the static charge which might have built up on surface of the LEDs plastic lens as a result of friction between LEDs during storage and handing

Suggested checking list:

Training and Certification

- 6.7.1.1. Everyone working in a static-safe area is ESD-certified?
- 6.7.1.2. Training records kept and re-certification dates monitored?

Static-Safe Workstation & Work Areas

- 6.7.2.1. Static-safe workstation or work-areas have ESD signs?
- 6.7.2.2. All surfaces and objects at all static-safe workstation and within 1 ft measure less than 100V?
- 6.7.2.3. All ionizer activated, positioned towards the units?
- 6.7.2.4. Each work surface mats grounding is good?

Personnel Grounding

- 6.7.3.1. Every person (including visitors) handling ESD sensitive (ESDS) items wear wrist strap, heel strap or conductive shoes with conductive flooring?
 - 6.7.3.1. If conductive footwear used, conductive flooring also present where operator stand or walk?
 - 6.7.3.2. Garments, hairs or anything closer than 1 ft to ESD items measure less than 100V*?
 - 6.7.3.3. Every wrist strap or heel strap/conductive shoes checked daily and result recorded for all DLs?
 - 6.7.3.4. All wrist strap or heel strap checkers calibration up to date?
- Note: *50V for Blue LED.

Device Handling

- 6.7.4.1. Every ESDS items identified by EIA-471 labels on item or packaging?
- 6.7.4.2. All ESDS items completely inside properly closed static-shielding containers when not at static-safe workstation?
- 6.7.4.3. No static charge generators (e.g. plastics) inside shielding containers with ESDS items?
- 6.7.4.4. All flexible conductive and dissipative package materials inspected before reuse or recycle?

Others

- 6.7.5.1. Audit result reported to entity ESD control coordinator?
- 6.7.5.2. Corrective action from previous audits completed?
- 6.7.5.3. Are audit records complete and on file?

7. Others

The appearance and specifications of the product may be modified for improvement, without prior notice.